

Solar Electric Propulsion Module Concept For The *Bifrost* Architecture

Rohrschneider, R. R.^{*}, Olds, J. R.[†], Sakai, T.^{*}, Steffes, S.^{*}, Grillmayer, G.^{*}, St. Germain, B.^{*}

Space Systems Design Lab
School of Aerospace Engineering
Georgia Institute of Technology, Atlanta GA, 30332-0150
reuben_rohrschnneider@ae.gatech.edu

ABSTRACT

This paper describes the design of a solar electric propulsion module for the *Bifrost* architecture. *Bifrost* consists of a magnetic levitation launch tube with the exit end elevated to 20 km. A 35,000 kg hybrid logistics module (HLM) is designed to attach to an array of propulsion modules that accommodate different missions. The solar electric propulsion (SEP) module is designed to circularize a payload in Geosynchronous Earth orbit (GEO) from a highly elliptic transfer orbit. A configuration consisting of a central spacecraft body propelling itself with electric thrusters and gathering solar power from two inflatable concentrating reflectors was chosen. Concentrating reflectors were chosen over thin film arrays due to the large mass savings.

Details of the conceptual design process are presented. Disciplines include trajectory, power system, propulsion, and weights & sizing. A computational framework was used to wrap the disciplinary analysis to speed the design process, and optimization was performed to minimize the initial mass of the vehicle from within the design framework. The resulting vehicle has an initial mass in orbit of 40,780 kg.

A demonstration model was then designed and constructed from the conceptual design. The manufacturing process for the inflatable reflector and

the spacecraft body are described in detail. The demonstration model shows that an inflatable reflector is a feasible method of generating large amounts of power in space.

NOMENCLATURE

AKM	Apogee Kick Motor
CAD	Computer Aided Design
DSM	Design Structure Matrix
GEO	Geosynchronous Earth Orbit
HLM	Hybrid Logistics Module
Isp	Specific Impulse (sec.)
MERs	Mass Estimating Relationships
SEP	Solar Electric Propulsion

INTRODUCTION

Humanity has dreamed of expanding their realm to include space and other planetary bodies and to use space to improve our own planet. Most of these goals require a large mass in Earth orbit. However, before this becomes practical the cost of access to space must be reduced drastically. *Bifrost* is one of many 4th generation launch concepts designed to reduce the cost of access to space, and hence enable projects such as space solar power and human exploration of other planets. The overall architecture is based on a concept developed by Powel et al [1].

This paper concentrates on the propulsion module designed to take a payload from a highly elliptical transfer orbit to GEO. After release from the magnetic-levitation launch tube the propulsion module must be capable of circularizing the HLM in GEO from a highly elliptic orbit. Constraints are imposed

^{*} - Graduate Research Assistant, Georgia Institute of Technology, Atlanta GA, 30332

[†] - Associate Professor, Georgia Institute of Technology, Atlanta GA, 30332

by the launch tube diameter and aerodynamic fairings on the vehicle.

A SEP system was chosen to provide thrust since the time of flight was not constrained, and the high specific impulse (Isp) would allow a large payload fraction. Several concepts exist for SEP systems including the traditional rigid solar panels, thin film solar arrays, solar concentrators using lenses, and solar concentrators using reflectors. The reflector system was chosen, allowing the array to be placed very close to the high power components, requiring less power distribution and management, and hence improving system efficiency. Additionally, inflatable reflectors offer a significant weight advantage over rigid solar panels on satellites.

Once the conceptual design was finished, more detailed design was undertaken, resulting in a demonstration model. This process included packaging of the reflectors and lenses within the spacecraft for launch, fabrication methods for the inflatable lens and the supporting struts, and an electronics package to show that the concentrator works. This type of vehicle is lighter and potentially cheaper than a comparable vehicle made with thin film arrays, and the concentrating reflector was shown to be a viable means of boosting power.

CONCEPT OVERVIEW

Bifrost is a 4th generation launch architecture that could drastically reduce the cost of placing payloads in Earth orbit and beyond. It consists of a magnetic-levitation launch tube on the equator with one end elevated to approximately 20 kilometers above sea level. Logistics modules with attached propulsion modules and aerodynamic fairings are accelerated through the launch tube at speeds varying according to the desired orbit. The propulsion module attached to each logistics module must then provide the velocity to achieve the desired final orbit. *Bifrost* is setup to launch a common HLM with a number of different propulsion modules suited for different in space applications.

The SEP module, shown in Figure 1, is designed to take a 35,000 kg HLM from the end of the launch

tube to GEO. The module makes use of inflatable technology to reduce the mass of solar power generation system, and electric propulsion for its efficiency.



Figure 1: The SEP module shown in Earth orbit.

Mission Profile

Once the SEP vehicle and HLM exit the *Bifrost* launch tube on the equator, and a sufficiently low dynamic pressure is reached, the nose and tail cones are jettisoned. The vehicle then coasts to an apogee altitude of 28,620 km, when a solid apogee kick motor (AKM) is fired to raise the perigee from 20 km to 100 km. Raising the perigee is necessary to reduce drag, so the vehicle doesn't crash into the launch site after one orbit. The two lens assemblies are then deployed, and the reflectors inflated. The SEP module uses its ion engine for about 60° centered on apogee, for the next 1000 orbits, to reduce the eccentricity of its orbit to zero. The orbit is then raised by continuous thrusting until the vehicle reaches GEO, where the payload is deployed. A notional trajectory is sketched in Figure 2.

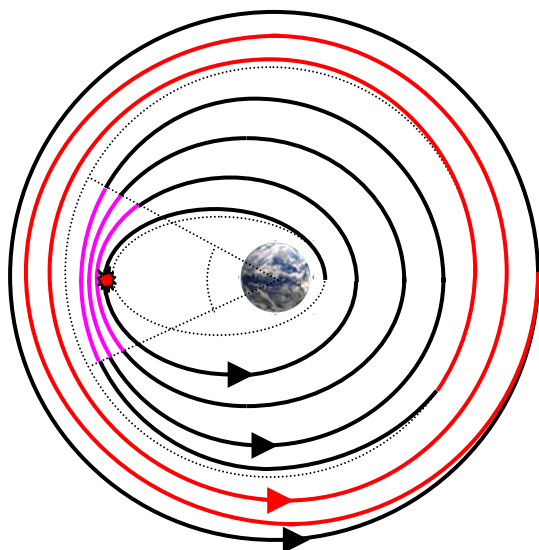

Figure 2: Notional spiral trajectory showing circularization, and the orbit rising to GEO.

DESIGN METHOD

The SEP module for *Bifrost* was designed using multi-disciplinary methods. Each team member created a tool to analyze one aspect of the SEP module and a computational framework was used to link them together across multiple computer platforms. A design structure matrix (DSM) is a convenient way to show the coupling between the disciplines used to analyze a design. In a DSM data flow is clockwise, such that lines in the upper right represent feed-forward, and lines in the lower left are feed-back. Figure 3 shows the DSM for this design problem. The two feed-back loops in the DSM are the reason iteration is necessary to converge the design.

Four main disciplinary analyses were included in the design process: trajectory, power, propulsion, and weights & sizing. The trajectory analysis takes the vehicle mass and thrust and calculates the required propellant mass fraction to reach the desired orbit. The power analysis takes the reflector and solar array parameters and finds the power available in Earth orbit. The propulsion analysis takes the available power and calculates the available thrust. The weights & sizing analysis takes parameters from all of the preceding analyses and calculates a total vehicle mass, which is then compared to the initial guess given to the trajectory analysis. If they are the same, then the

design is converged. If they are not, the analyses are iterated on until the guess is the same as the calculated output. The disciplinary analyses are explained in more depth in the following sections of this paper.

The computational framework ModelCenter® was used to link the disciplinary analyses, to perform the iteration, and to optimize the vehicle. The use of a computational framework saved a large amount of time over the traditional method of passing variables manually between team members and enabled numerical optimization of the entire vehicle.

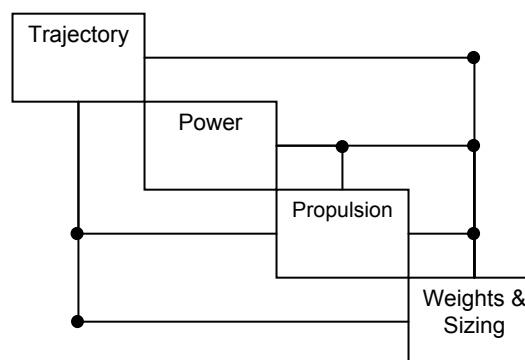

Figure 3: DSM for the SEP module design.

DISCIPLINARY ANALYSES

Configuration

The power generation system and the geometry constraints imposed by the launch tube are the primary drivers in the vehicle configuration. Once a vehicle configuration was decided on, Pro/Engineer® was used to help determine vehicle packaging and position of the inflatable reflectors. The solid models are used to determine constraints on the location and size of the inflatable reflectors during the optimization process. All necessary data is transferred from the computer aided design (CAD) model to a spreadsheet for easy access while performing iteration and optimization.

The dynamic response of large gossamer structures pushed the design towards two reflectors rather than one. The desire to reduce power transmission losses placed the solar arrays close to the engines, and the launch tube diameter of 5 meters

required that the reflector and lens assemblies be deployable. Packaging of the reflector and lens assemblies then determined the length of the propulsion module. The final configuration is shown in Figure 4.

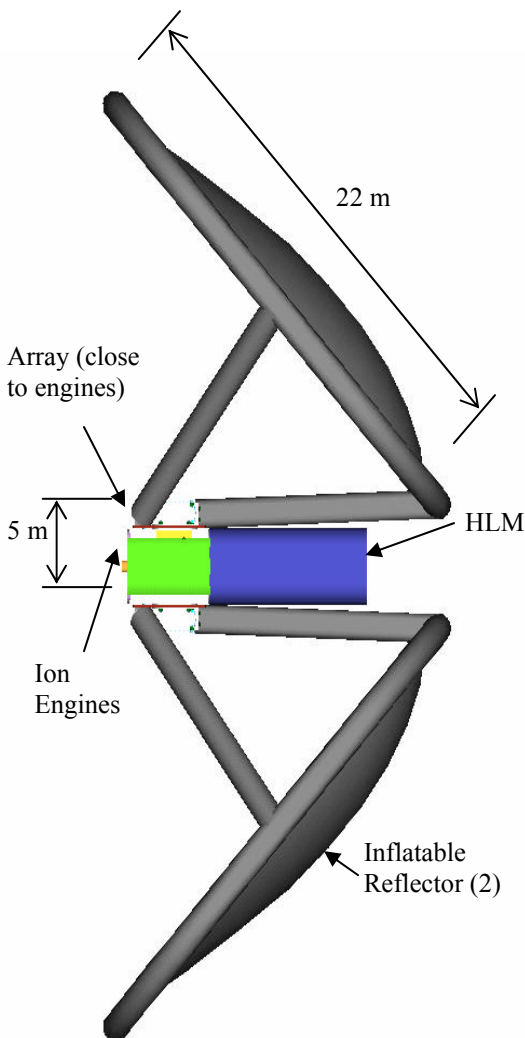

Figure 4: Configuration of the SEP module. HLM attaches on the right.

Trajectory

Trajectory analysis was performed using an in-house numerical integration code. Cowell's method [2] was chosen for its simplicity, and the ease with which additional influences may be added. A 4th order Runge-Kutta numerical integration scheme is used with 5th order error correction and adaptive time step [3,4] to improve the computation time. The program

is capable of setting multiple engine starts and stops, sideslip angle, and angle of attack based on true anomaly. A gravity model including J_2 terms is incorporated into the program along with aerodynamic drag at low altitudes. Several stopping conditions are available including eccentricity, radius, and inclination.

Since the perigee of the initial transfer orbit is within the atmosphere, the first thrust maneuver must increase the perigee above the atmosphere. The low thrust electric propulsion cannot provide a sufficient boost in one orbit, so a solid AKM was added to the design. Reliability of the reflector deployment was also a concern, and the addition of an AKM solves this problem. The initial boost from the AKM was sized using a spreadsheet and the new position and velocity were then passed to the numerical integration trajectory program.

Two steps were required for the trajectory from the launch tube to GEO. The first step used eccentricity as the stopping condition and commanded thrust for about 60° centered on apogee. The next phase used continuous thrust to increase the orbital radius until GEO was reached. Both phases maintained the thrust parallel to the velocity vector. The Earth shades the vehicle for only 4.8% of the orbital period, and so was not accounted for. Since the SEP module only thrusts for 60° of the orbit, launch timing can be used to determine the argument of periapse to keep the thrust segment out of the shadows during circularization.

Propulsion System

The propulsion system analysis calculates thrust for an ion engine based on a propellant type, exhaust velocity and available power. Using the available power, the Isp is calculated. A curve fit of thruster efficiency as a function of Isp from [5] is used to get the thrust after reducing the input power to account for the power processing unit.

Ion engines were chosen due to their high thrust efficiency at moderate to high Isp. Engines using Xenon, Krypton, and C60 were all analyzed, and the engine with the highest thrust at the prescribed Isp was used.

Engine mass was also calculated using a curve fit from [5], and accounts for the engine, and the power processing unit. Tank mass, and propellant are calculated in the weights & sizing analysis.

Power Generation

Due to the choice of propulsion system, a large power source is needed. To be environmentally friendly, a solar collector was chosen. Two methods of solar power generation were explored. One uses a traditional thin film solar array with deployable booms. The other uses an inflatable concentrating reflector system with the solar arrays very close to the engines.

Concentrating Reflector

Several constraints were placed on the concentrating reflector by the vehicle configuration. The reflector must gather light from a position on the side of the vehicle, the reflector must rotate about an axis perpendicular to the vehicle's long axis, the array must be close to the engines, and the rear support strut must rise from the lens to the reflector (so it doesn't block light).

In order for the reflector to concentrate light at a point, a parabolic shape must be used. For the remainder of this paper, the parabola constant refers to the constant in front of the squared term in the equation for a parabola. The constraint that the reflector gather light from the side of the vehicle requires that a section of a parabola be used that is defined by the desired magnification, the parabola constant, and the desired location of the mirror relative to the lens. The rotation constraint, along with the use of solar cells, dictates that the beam of light onto the array must be uniform about the axis of rotation. This means that the light must be straightened by a lens, and the usable beam must be a cylinder, which is then reflected by a mirror onto the solar cells. Finally, the angle of the rear support must be large enough that the support rises more than its diameter over its length, such that it does not block any light between the reflector and the lens. The configuration defined by these constraints is sketched in Figure 5.

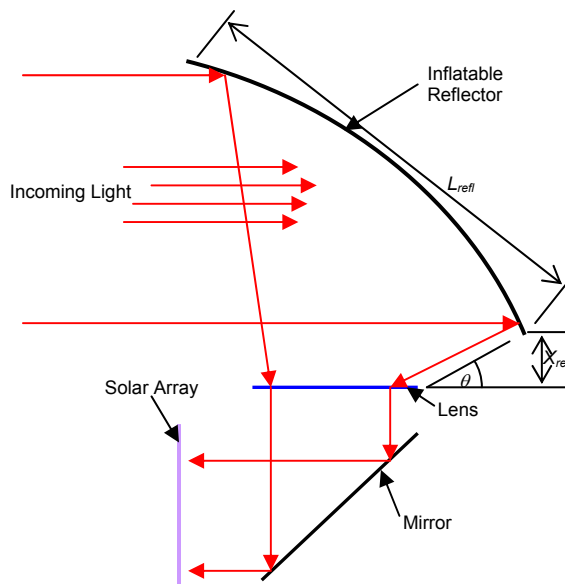

Figure 5: Schematic of the concentrating reflector.

Solar cells were chosen for the power generation due to their light weight and simplicity. Typically a high efficiency solar cell has an electric conversion efficiency of 26% at one sun. Since cell efficiency rises with solar concentration up to 300 suns for GaInP₂/GaAs/Ge triple junction cells [6] an electric conversion efficiency of 30% was assumed. Due to the high solar radiation, a large amount of heat must be dissipated to maintain the solar cell temperature in a reasonable range. This results in an increase in radiator mass that is accounted for in the weights & sizing analysis. Total mass for the concentrating reflector system at 86.8 kW is 900 kg.

Thin Film Arrays

The thin film array assumes a structural unit weight of 0.1325 kg/W (3710 kg/28 kW) [7], which is based on the International Space Station arrays. Mass was determined using the same power for both systems. For the design reference of 86.8 kW this results in an array mass of 11,500 kg.

Additionally, location of the solar arrays close to the engines results in a savings of approximately 4% over running wires to traditional solar arrays outside the vehicle. Copper wires running to an equivalent power solar array were used for this calculation. The difference in wire mass is less than 20 kg, but the overall power system mass is lower for the

concentrating reflector design. Packaging for the thin film array system may be an issue, though it was not explored since mass was enough to rule out this system. Overall the concentrating reflector is a lower mass system for the power output, and a better overall solution for this design.

Weights & Sizing

The weights and sizing analysis for the SEP module consists of a spreadsheet containing parametric mass estimating relationships (MERs). The spreadsheet takes data from the configuration analysis, the power system analysis, the trajectory analysis, and the propulsion analysis to calculate the mass of the SEP module. Since changing the mass ratio and thrust change the mass of the vehicle, iteration must be performed until the vehicle converges.

Table 1: Mass breakdown statement for the optimized SEP module.

Component	Mass (kg)
Structure	1,450
Power Generation	830
Power Distribution	50
Thermal Control	190
Propulsion	480
Control and Avionics	110
Margin (20%)	620
Dry Mass	3,730
Reserves and Residuals	90
Pressurant	1
Payload	35,000
GEO Mass	38,820
Boost Propellant Mass	1,790
M_{init}	40,610
AKM Mass	170
Initial On Orbit Mass	40,780

The MERs used are based on near term technology which assumes that structural elements are aluminum or carbon/epoxy composite. Mass for the inflatable reflector was modeled as a mass per area of inflatable where this metric was assumed to be comparable to existing systems built by L'Garde [8]. A rigidizing structure was used such that replenishment gas is not required to keep the structure inflated. Advanced light weight avionics and titanium

tanks are also assumed. A twelve point mass breakdown statement for the optimized vehicle design is shown in Table 1.

OPTIMIZATION

Use of a computational framework enabled system level numerical optimization. Each of the disciplinary analyses were wrapped and added to the model. In addition to the disciplinary analysis, several built in optimization methods are available. The design was converged using a script component that performs fixed point iteration.

After several trial runs, sequential quadratic programming was chosen as the most effective optimization scheme of those available in ModelCenter®. The optimization process used the normalized initial mass for the objective function, with the goal to minimize this quantity. Table 2 lists the constraints and the design variables with their upper and lower bounds. θ , the angle of the rear reflector support strut is limited to prevent shading from the strut. The rear strut length, D_I , and the overall reflector length, L_{refl} , are limited in size to keep the structural dynamics problems to a minimum. Side constraints were placed on the parabola constant, X_{refl} , exhaust velocity, and magnification to keep them within physically reasonable bounds. The design variables are the parabola constant, the position of the lower edge of the reflector, X_{refl} , the exhaust velocity, and the magnification. All other quantities were fixed due to the *Bifrost* launch architecture.

Table 2: Constraints and design variables with their bounds.

Variable	Lower Bound	Upper Bound
θ (deg.)	3	None
D_I (m)	None	60
L_{refl} (m)	None	45
Parabola Const.	0.001	0.1
X_{refl} (m)	0.01	1.0
Exhaust Vel. (m/s)	14,000	40,000
Magnification	40	800

To aid the optimizer, the objective function, the constraints, and the design variables were all normalized. The default settings were used for finite difference gradients and convergence.

RESULTS

On completion of the optimization, the vehicle had lost significant mass from the initial guesses for the design variables. The final values of the design variables and select outputs are shown in Table 3. All variables are up against constraints except for the parabola constant, and the reflector dimensions L_{refl} and D_l . Since no time constraint was specified the exhaust velocity is at the maximum allowed for ion engines to maximize the engine Isp, and hence reduce mass. The reflector dimensions are primarily derived from the exhaust velocity since this determines the power required and the reflector size. Trip time came to 575 days due to the lack of a time constraint. Depending on the cargo, this trip time may not be acceptable. Earlier in the design process optimization was performed with a minimum thrust constraint of 13 Newtons, resulting in a trip time of 190 days, but a much higher initial mass of 49,530 kg.

Table 3: Design variables and selected outputs after optimization.

Variable	Value
Parabola Constant	0.03476
X_{refl} (m)	0.9779
Magnification	40.0
Exhaust Velocity (m/s)	40,000
θ (deg.)	3.0
D_l (m)	18.7
L_{refl} (m)	22
A_{refl} (m ²)	305
Mass Ratio	1.04622
M_{init} (kg)	40,610
Propellant Mass (kg)	1,790
Engine Thrust (N)	4.22
Engine Isp (sec)	4,077
Engine Propellant	Xenon

DEMONSTRATION MODEL

Once the paper design was finished, further detail was put into the model in order to construct a 1/20th scale demonstration model. Additional detail was mainly required for manufacturing purposes. The basis for the scale model was an early version of the design prior to optimization. It had a higher magnification (72), and a higher engine thrust. Vehicle body dimensions were nearly identical due to the diameter constraints, and high packaging efficiency of inflatable structures. The earlier model was chosen so that work could begin on hardware prior to completion of the optimization. Initial tests were performed to verify our concepts, and then the final parts were manufactured. The majority of the work was performed by the graduate research assistants in the Space Systems Design Lab with some assistance from the Aerospace Engineering department machine shop.

Inflatable Reflector

The construction of the inflatable reflector was the largest unknown for the demonstration model. The initial concept to heat a mylar sheet and stretch it over a mold was tested with a small mylar sheet and a cooking bowl. Initially the mylar was held by hand and pulled over the bowl. This method worked, but it was easier to shrink the mylar (rather than stretch it) with a heat gun. The next test used tape around the edge of the bowl to secure the mylar. This also worked, but a better surface finish was obtained when some tension was applied to the mylar during the heating process.

To transfer this process to the reflector of the demonstration model, a mold for the mirror shape was necessary. The mold was constructed using cross sections cut from 3 inch thick tooling foam. The cross sections were glued together on a rigid base, and hand sanded until the desired shape was achieved. To obtain a smooth surface, the surface of the foam required coating. Several different paints and adhesives were tried, but all were too thin, and most couldn't handle the temperature required to shrink the mylar. The final solution was to fill high temperature paint with glass bubbles. This produced a good surface finish in only two coats, and with minimal

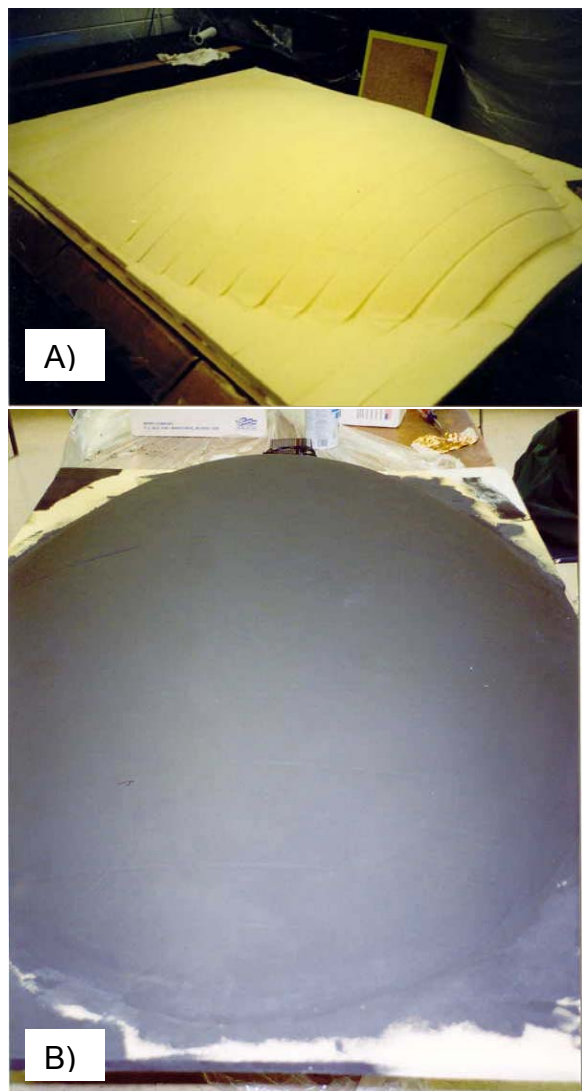

Figure 6: Foam mold in various states of construction. A) Foam mold partly sanded. The steps from the initial cut lines are still partially visible. B) Foam mold sanded and coated.

sanding required. Figure 6 shows the foam mold in various states of the construction process.

Stretching the mylar over the foam mold proved to be difficult due to the size of the part, so a template and supporting frame were constructed to aid the process. Shrinking the mylar with a heat gun over such a large part turned out to be difficult due to the large wrinkles. Making the part from three gores reduced the initial wrinkling and improved the final shape obtained by making the shrinking process easier. Mylar tape was chosen for attaching the gores together since the shrink rate would then match that of

the gores. Figure 7 shows the reflector surface in mid-heating process.

The reflector support structure consists of a circular tube to stretch the reflector, and three supporting tubes to position the reflector relative to the vehicle. The circular tube was constructed by wrapping mylar around a cylindrical mandrel and using mylar tape to secure the free edges to each other. No shrinking of the circular tube was performed, so wrinkles will exist on the inner diameter of the ring. Figure 8 shows the construction process of the support ring. The ring is attached to the reflector with nylon strands, and one small air tube to allow inflation through the struts. The three struts are made around the same tapered mandrel. A tapered mandrel was used because packaging of the tubes at the diameter of the ring support was not possible. The small end of each strut is attached to an acrylic cylinder rigidly affixed to the spacecraft body. The large end of each strut is glued to the support ring, and a small hole is made between the two so inflation can be performed from the base of the struts.

The inflation system consists of a continuously operating low pressure pump, two valves, and several sections of hose. A continuous air supply is necessary since sealing the structure completely is very difficult

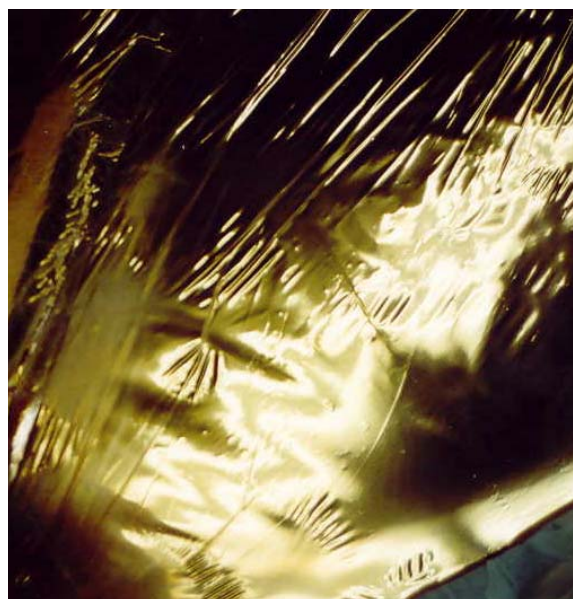

Figure 7: Inflatable reflector surface in mid-heating process. Note the wrinkles in some areas where the mylar hasn't been shrunk yet.



Figure 8: The struts and support tube are carefully wrapped around a mandrel and taped together.

when using tape to join parts. A rigidizable material prevents this problem, and eliminates the need for replenishment gas on the real vehicle.

Vehicle Body

The demonstration model makes use of the low cost and easy machining of nylon sheet in the vehicle body. Two components make up the spacecraft body: the main body, and the rotation table that supports the inflatable reflector. The majority of the parts comprising the spacecraft body were manufactured using a computer numerically controlled mill for speed and accuracy.

In the main vehicle body, the primary structure is an extruded “H” shape with round end caps. Another plastic sheet is used to support the mirror at a 45° angle. Each array bolts to one end of the vehicle. Figure 9 shows the CAD model of the main spacecraft body. The majority of the vehicle is assembled using bolts for quick assembly and easy access after construction.

The rotation table is also constructed primarily by bolting together plastic sheets. An acrylic tube with a plug glued into one end is used to attach the inflatable struts to the rotation table. Adhesive was also used to attach the tubes to the rotation table, and

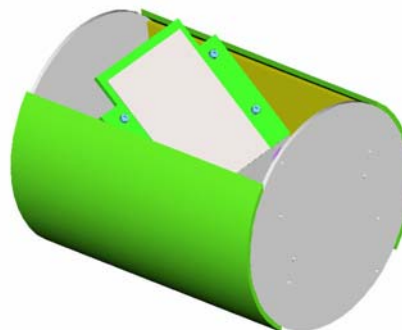

Figure 9: CAD model of the demonstration model’s main spacecraft body.

to attach the air fittings to the tubes. The rotating mechanism is constructed from three rings with the same inner diameter that form a groove in the outer diameter. The rotation table, containing the lens and attachment hardware for the struts, fits in the groove in the outer diameter of the three rings. The three rings are then bolted to the main body of the model, allowing the lens and tubes to rotate. The lens was formed by machining two Fresnel lenses and stacking them to achieve the desired focal length. This was done due to lead time and cost of a custom lens. A CAD model of the rotation table is shown in Figure 10.

A deployment mechanism is necessary in the real vehicle. Due to the small size of the demonstration model, the mechanism would be very difficult to manufacture, and so was left out of the model. Only

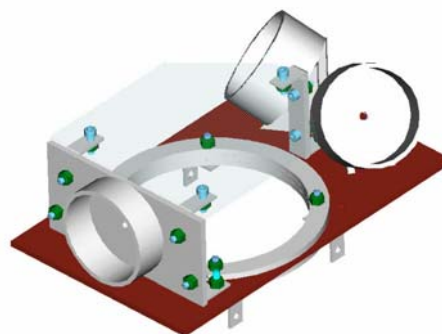

Figure 10: CAD model of the demonstration model’s rotation table.

one side of the model was built since this was adequate to demonstrate the concept.

CONCLUSIONS

The solar electric propulsion module is designed to take a 35,000 kg payload from a highly elliptical transfer orbit and circularize it in GEO. Two solar power generation techniques, thin film arrays and inflatable concentrating reflectors, were explored. The thin film arrays proved to be much heavier than the inflatable concentrators for the same power generation. The final configuration consisted of a spacecraft central body with two inflatable concentrators attached to rotating fixtures.

Disciplinary analyses were wrapped in a computational framework, and system level optimization was performed. The optimized design pushed the engine exhaust velocity to the upper limit to reduce the overall vehicle mass. This resulted in a vehicle with an initial mass on orbit of 40,780 kg.

A demonstration model was built, and showed that the system could be packaged in the available space, and that an inflatable reflector is a feasible means of increasing the available power per unit mass of the system.

REFERENCES

1. Powell, J.R., Maise, G., Paniagua, J., Rather, J.D.G., "StarTram: A New Approach for Low-Cost Earth-to-Orbit Transport," IEEE 0-7803-6599-2/01, 2001.
2. Bate, Mueller, White, Fundamentals of Astrodynamics, New York: Dover Publications, Inc., 1971.
3. Cheney, Kincaid, Numerical Mathematics and Computing, Brooks/Cole Publishing Co., 1994.
4. Vandergraft, Introduction to Numerical Computations: Second Edition, New York: Academic Press, 1983.
5. Henry, Humble, Larson, Space Propulsion Analysis and Design, New York: McGraw Hill, 1995.
6. Triple Junction Terrestrial Concentrator Solar Cells, Sylmar: Spectrolab Inc., 2000.
7. Larson, Human Space Mission Analysis and Design, New York: McGraw Hill.
8. Cassapakis C., Lichodziejewski D., "Inflatable Power Antenna Technology," AIAA paper 99-1074, January 1999.